

真空氣動閥

1/4"~3/8"

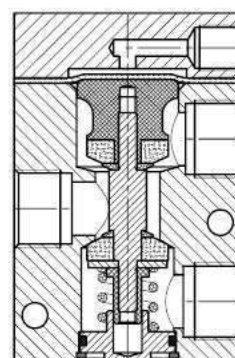

常闭

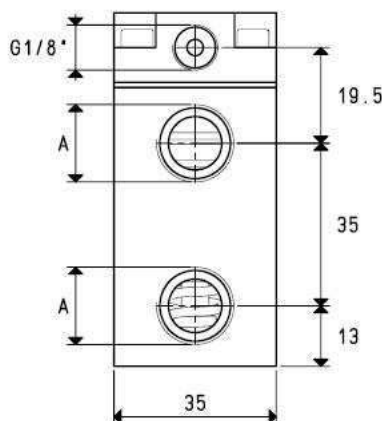
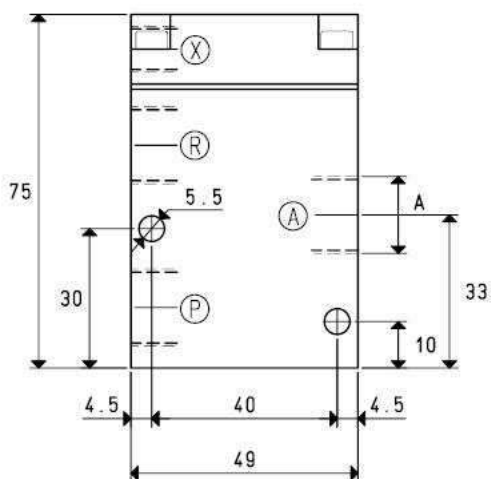
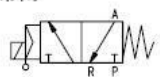

X: 压缩空气入口
P: 泵
A: 作用端
R: 卸压端

常开



X: 压缩空气入口
P: 卸压端
A: 作用端
R: 泵

型號	A	最大流量 cum/h	真空度(mbar abs.)		反應時間(msec)		φ 孔徑	通孔面積 mm ²	控制壓力 *Bar(g)	重量 kg
	φ		最小	最大	勵磁	消磁				
VV 07 01 31	G1/4"	6	1000	0.5	5	10	8.5	56.8	4 ÷ 7	318
VV 07 02 31	G3/8"	10	1000	0.5	5	10	11.5	103.8	4 ÷ 7	308

單位轉換:1 英寸=25.4 毫米; 1 英鎊=453.6 克=0.4536 千克

真空氣動閥

1/2"~1"

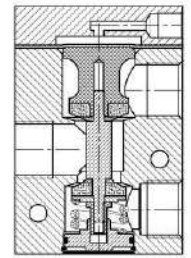
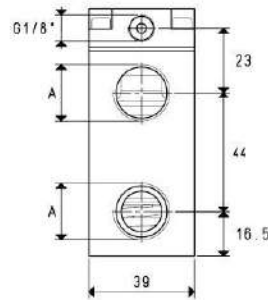
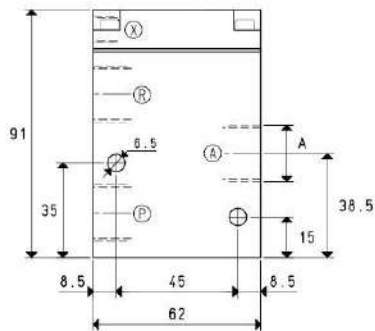

常闭

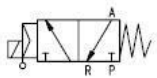

X: 压缩空气入口
P: 泵
A: 作用端
R: 卸压端

常开



X: 压缩空气入口
P: 卸压端
A: 作用端
R: 泵

型號	A φ	最大流量	真空度(mbar abs.)		反應時間(msec)		φ 孔徑	通孔面積 mm ²	控制壓力 *Bar(g)	重量 kg
		cum/h	最小	最大	勵磁	消磁				
VV07 03 31	G1/2"	20	1000	0.5	6	15	15.0	176	6 ÷ 8	0.490

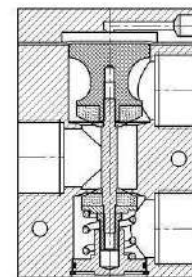
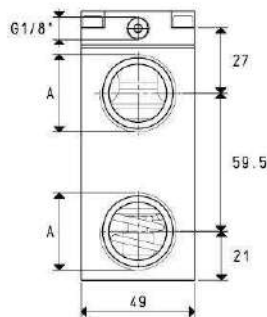
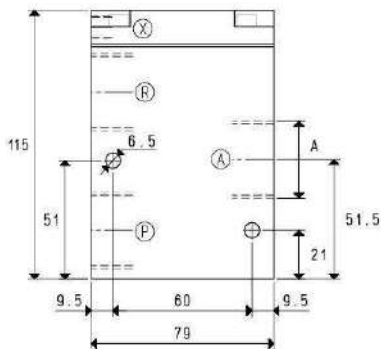

常闭

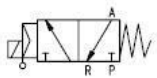

X: 压缩空气入口
P: 泵
A: 作用端
R: 卸压端

常开



X: 压缩空气入口
P: 卸压端
A: 作用端
R: 泵

型號	A φ	最大流量	真空度(mbar abs.)		反應時間(msec)		φ 孔徑	通孔面積 mm ²	控制壓力 *Bar(g)	重量 kg
		cum/h	最小	最大	勵磁	消磁				
VV07 04 31	G3/4"	40	1000	0.5	7	16	20	314	6 ÷ 8	1.060
VV07 05 31	G1"	90	1000	0.5	7	16	25	490	6 ÷ 8	0.964

單位轉換: 1 英寸=25.4 毫米; 1 英鎊=453.6 克=0.4536 千克

真空氣動閥

1¹/₂"

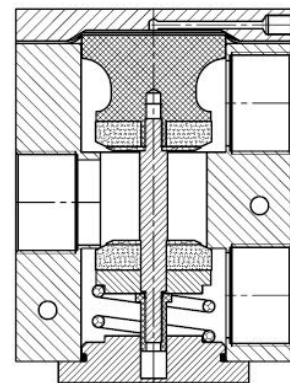
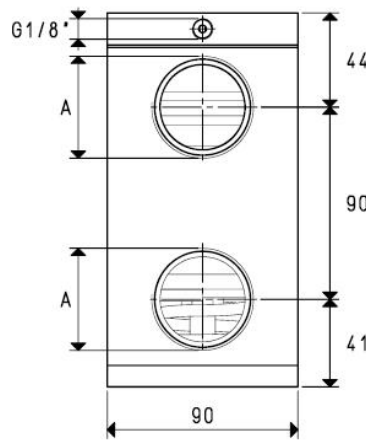
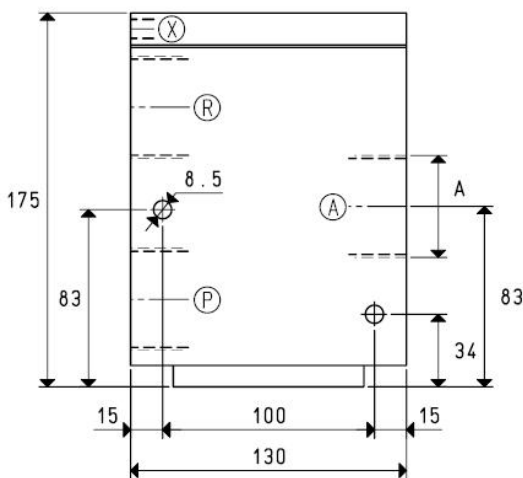

常闭

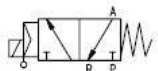

X: 压缩空气入口
P: 泵
A: 作用端
R: 卸压端

常开

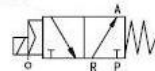

X: 压缩空气入口
P: 卸压端
A: 作用端
R: 泵

型號	A	最大流量 cum/h	真空度(mbar abs.)		反應時間(msec)		φ 孔徑	通孔面積 mm ²	控制壓力 *Bar(g)	重量 kg
	φ		最小	最大	勵磁	消磁				
VV 07 06 31	G1 ¹ / ₂	180	1000	0.5	65	30	40	1256	6 ÷ 8	4.456

單位轉換: 1 英寸=25.4 毫米; 1 英鎊=453.6 克=0.4536 千克