

GU LINE





Innesti Rapidi
Couplings
Coupleurs
Kupplungen





GU 20	Innesto rapido DN2,5	Coupler DN2,5	Coupleur DN2,5	Kupplung DN2,5	
1	2	3	4	5	
Corpo Body Corps Körper	Otturatore Valve Clapet Ventil	Molle Springs Ressorts Feder	Guarnizioni Seals Joint d'étanchéité Dichtung	Sfere Balls Billes Kugel	Innesti Plugs Embouts Stecker
Ottone UNI EN 12164 CW614N Nichelato Brass UNI EN 12164 CW614N Nickel plated Laiton UNI EN 12164 CW614N Nickelé Ms Vernickelt UNI EN 12164 CW614N	Ottone UNI EN 12164 CW614N Brass UNI EN 12164 CW614N Laiton UNI EN 12164 CW614N Messing UNI EN 12164 CW614N	Acciaio Inox AISI 302 Stainless Steel AISI 302 Acier Inox AISI 302 Edelstahl AISI 302	NBR NBR NBR NBR	Acciaio Inox AISI 420 Stainless Steel AISI 420 Acier Inox AISI 420 Edelstahl AISI 420	Ottone UNI EN 12164 CW614N Nichelato Brass UNI EN 12164 CW614N Nickel plated Laiton UNI EN 12164 CW614N Nickelé Ms Vernickelt UNI EN 12164 CW614N



 -20°C ÷ 80°C



 0 ÷ 15 bar



 2,5 mm



 170 NI/min
(6 bar - Δp = 1bar)

 SILICONEFREE

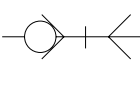
 RoHS

 REACH

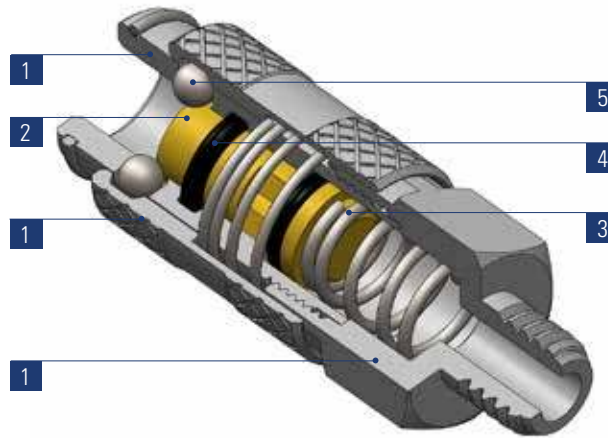
 Scala 1:1
 Scale 1:1
 Echelle 1:1
 Maßstab 1:1



Campi di applicazione:
Impianti pneumatici.

Application fields:
Pneumatic circuits.

Domaines d'application:
Circuits pneumatiques.

Anwendungsbereiche:
Pneumatische Anlagen.

GU 20-11

Innesto rapido con filetto maschio

Male coupling

Coupleur mâle

Einschraubkupplung

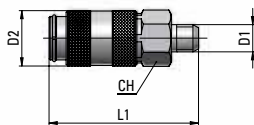

Tipo	D1	D2	L1	CH	g Δ
11 00 M5	M5x0,8	10	27	9	10
11 00 18	G1/8	10	29	12	14

GU 20-12

Innesto rapido con filetto femmina

Female coupling

Coupleur femelle

Aufschraubkupplung

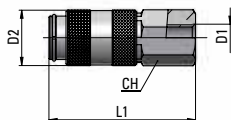

Tipo	D1	D2	L1	CH	g Δ
12 00 M5	M5x0,8	10	27	9	11
12 00 18	G1/8	10	29	12	15

GU 20-13

Innesto rapido con portagomma

Coupling with hose connection

Coupleur avec douille cannelée

Kupplung mit Schlauchtülle

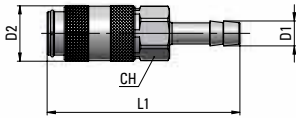

Tipo	Øi Tubo	D1	D2	L1	CH	g $\Delta\Delta$
13 03 00	3	3,6	10	36	9	9
13 04 00	4	4,6	10	36	9	10

GU 20-15

Innesto rapido con calzamento

Coupling with Nut fitting

Coupleur avec raccord à écrou

Kupplung mit Überwurfverschraubung

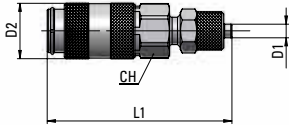

Tipo	D1	D2	L1	CH	g $\Delta\Delta$
15 04 00	4x2,5	10	33	9	11
15 06 00	6x4	10	35	9	13

GU 20-20

Innesto con filetto maschio

Male plug

Embout mâle

Einschraubverschlußsnippel

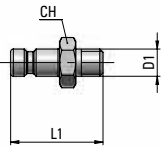

Tipo	D1	L1	CH	g $\Delta\Delta$
20 00 M5	M5x0,8	17	8	3
20 00 18	G1/8	20	12	7

GU 20-21

Innesto con filetto femmina

Female plug

Embout femelle

Aufschraubverschlußsnippel

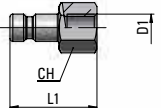

Tipo	D1	L1	CH	g $\Delta\Delta$
21 00 M5	M5x0,8	16	8	3
21 00 18	G1/8	19	12	6,5

GU 20-22

Innesto con portagomma

Plug with hose connection

Embout avec douille cannelée

Schlauchtülle

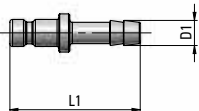

Tipo	Øi Tubo	D1	L1	g $\Delta\Delta$
22 03 00	3	3,6	24	2
22 04 00	4	4,6	24	2,5

GU 20-23

Innesto con raccordo a calzamento

Plug with Nut Fitting

Embout avec raccord à écrou

Verschlußtülle mit Überwurfmutter

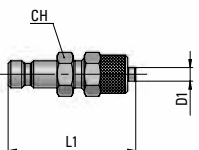

Tipo	D1	L1	CH	g $\Delta\Delta$
23 04 00	4x2,5	23	7	4
23 06 00	6x4	25	8	6

GU 21		Innesto rapido DN5	Coupler DN5	Coupleur DN5	Kupplung DN5
1	2	3	4	5	
Corpo Body Corps Körper	Otturatore Valve Clapet Ventil	Molle Springs Ressorts Feder	Guarnizioni Seals Joint d'étanchéité Dichtung	Sfere Balls Billes Kugel	Innesti Plugs Embouts Stecker
Ottone UNI EN 12164 CW614N Nichelato Brass UNI EN 12164 CW614N Nickel plated Laiton UNI EN 12164 CW614N Nickelé Ms Vernickelt UNI EN 12164 CW614N	Ottone UNI EN 12164 CW614N Nichelato Brass UNI EN 12164 CW614N Nickel plated Laiton UNI EN 12164 CW614N Nickelé Ms Vernickelt UNI EN 12164 CW614N	Acciaio Inox AISI 302 Stainless Steel AISI 302 Acier Inox AISI 302 Edelstahl AISI 302	NBR NBR NBR NBR	Acciaio Inox AISI 420 Stainless Steel AISI 420 Acier Inox AISI 420 Edelstahl AISI 420	Ottone UNI EN 12164 CW614N Nichelato Brass UNI EN 12164 CW614N Nickel plated Laiton UNI EN 12164 CW614N Nickelé Ms Vernickelt UNI EN 12164 CW614N



-20°C ÷ 80°C



0 ÷ 15 bar



5 mm



600 NI/min
(6 bar · Δp = 1bar)



SILICONEFREE



RoHS



REACH





Scala 1:1
Scale 1:1
Echelle 1:1
Maßstab 1:1

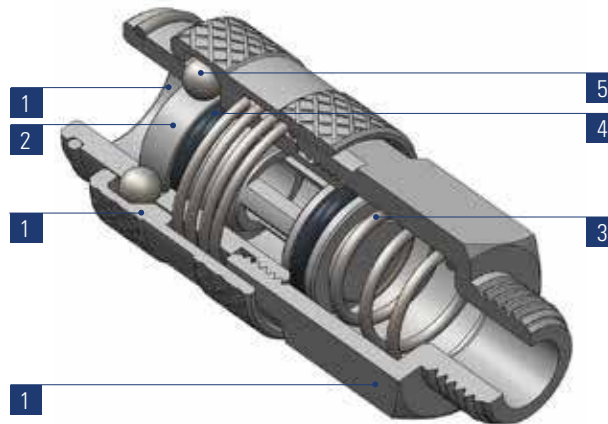

Campi di applicazione:
Impianti pneumatici.

Application fields:
Pneumatic circuits.

Domaines d'application:
Circuits pneumatiques.

Anwendungsbereiche:
Pneumatische Anlagen.

GU 21-11

Innesto rapido con filetto maschio

Male coupling

Coupleur mâle

Einschraubkupplung

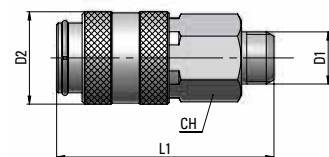

Tipo	D1	D2	L1	CH	g Δ
11 00 18	G1/8	16	40	14	27
11 00 14	G1/4	16	40	17	37

GU 21-12

Innesto rapido con filetto femmina

Female coupling

Coupleur femelle

Aufschraubkupplung

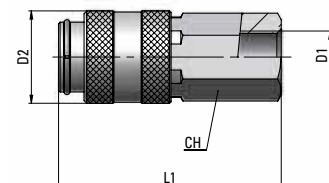

Tipo	D1	D2	L1	CH	g Δ
12 00 18	G1/8	16	40	14	35
12 00 14	G1/4	16	41	17	44,5

GU 21-13

Innesto rapido con portagomma

Coupling with hose connection

Coupleur avec douille cannelée

Kupplung mit Schlauchtülle

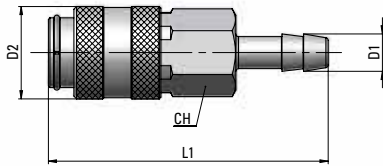

Tipo	Øi Tubo	D1	D2	L1	CH	g $\Delta\Delta$
13 04 00	4	5	16	50	14	25
13 06 00	6	7	16	50	14	32

GU 21-15

Innesto rapido con calzamento

Coupling with Nut fitting

Coupleur avec raccord à écrou

Kupplung mit Überwurfverschraubung

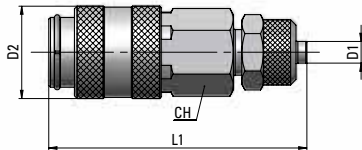

Tipo	D1	D2	L1	CH	g $\Delta\Delta$
15 06 00	6x4	16	47	14	37
15 08 00	8x6	16	48	14	38

GU 21-20

Innesto con filetto maschio

Male plug

Embout mâle

Einschraubverschlußnippel

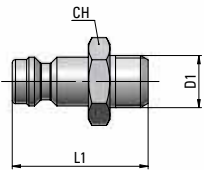

Tipo	D1	L1	CH	g $\Delta\Delta$
20 00 18	G1/8	25	14	11
20 00 14	G1/4	27	17	19

GU 21-21

Innesto con filetto femmina

Female plug

Embout femelle

Aufschraubverschlußnippel

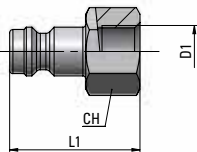

Tipo	D1	L1	CH	g $\Delta\Delta$
21 00 18	G1/8	25	14	13
21 00 14	G1/4	27	17	19

GU 21-22

Innesto con portagomma

Plug with hose connection

Embout avec douille cannelée

Schlauchtülle

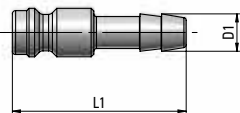

Tipo	Øi Tubo	D1	L1	g $\Delta\Delta$
22 04 00	4	5	32	6
22 06 00	6	7	32	6,5

GU 21-23

Innesto con raccordo a calzamento

Plug with Nut Fitting

Embout avec raccord à écrou

Verschlußtülle mit Überwurfmutter

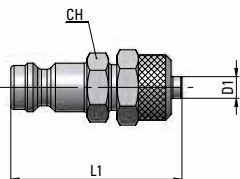

Tipo	D1	L1	CH	g $\Delta\Delta$
23 06 00	6x4	32	11	15
23 08 00	8x6	33	13	18

GU 21-24

Innesto con molla di protezione

Plug with hose protection spring

Embout avec ressort protection tube

Verschlussstübe mit Knickschutzfeder

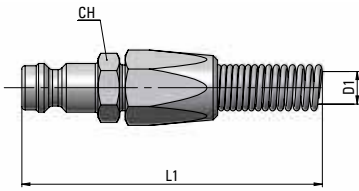

Tipo	D1	L1	CH	g 
24 06 00	6x4	110	11	24
24 08 00	8x6	120	13	31

Innesto rapido DN7,4

Coupler DN7,4

Coupleur DN7,4

Kupplung DN7,4

GU 26

1	2	3	4	5	
Corpo Body Corps Körper	Otturatore Valve Clapet Ventil	Molle Springs Ressorts Feder	Guarnizioni Seals Joint d'étanchéité Dichtung	Sfere Balls Billes Kugel	Innesti Plugs Embouts Stecker
Ottone UNI EN 12164 CW614N Nichelato Brass UNI EN 12164 CW614N Nickel plated Laiton UNI EN 12164 CW614N Nickelé Ms Vernickelt UNI EN 12164 CW614N	Ottone UNI EN 12164 CW614N Nichelato Brass UNI EN 12164 CW614N Nickel plated Laiton UNI EN 12164 CW614N Nickelé Ms Vernickelt UNI EN 12164 CW614N	Acciaio Inox AISI 302 Stainless Steel AISI 302 Acier Inox AISI 302 Edelstahl AISI 302	NBR NBR NBR NBR	Acciaio Inox AISI 420 Stainless Steel AISI 420 Acier Inox AISI 420 Edelstahl AISI 420	Ottone UNI EN 12164 CW614N Nichelato Brass UNI EN 12164 CW614N Nickel plated Laiton UNI EN 12164 CW614N Nickelé Ms Vernickelt UNI EN 12164 CW614N

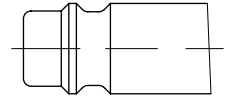

Profilo Europeo
European Profile
Profil européen
Europäisches Profil

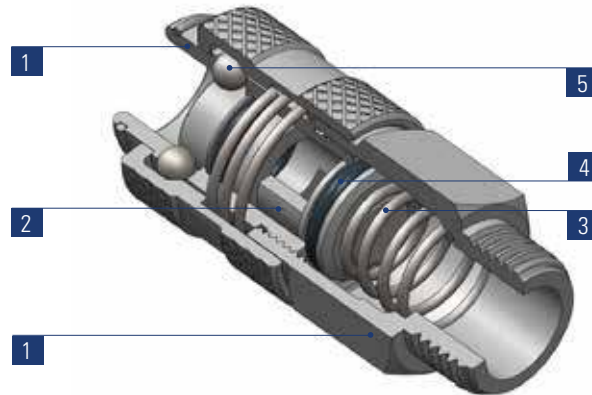

Campi di applicazione:
Impianti pneumatici.

Application fields:
Pneumatic circuits.

Domaines d'application:
Circuits pneumatiques.

Anwendungsbereiche:
Pneumatische Anlagen.

GU 26-11

Innesto rapido con filetto maschio

Male coupling

Coupleur mâle

Einschraubkupplung

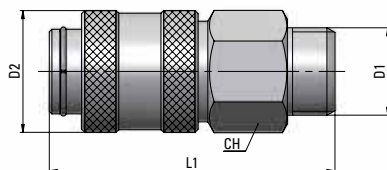

Tipo	D1	D2	L1	CH	g ΔΔ
11 00 14	G1/4	23	54	19	82
11 00 38	G3/8	23	54	20	89
11 00 12	G1/2	23	54	24	107

GU 26-12

Innesto rapido con filetto femmina

Female coupling

Coupleur femelle

Aufschraubkupplung

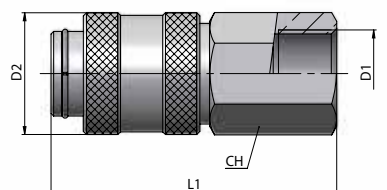

Tipo	D1	D2	L1	CH	g ΔΔ
12 00 14	G1/4	23	54	19	91
12 00 38	G3/8	23	54	20	90,5
12 00 12	G1/2	23	54	24	105

GU 26-13

Innesto rapido con portagomma

Coupling with hose connection

Coupleur avec douille cannelée

Kupplung mit Schlauchtülle

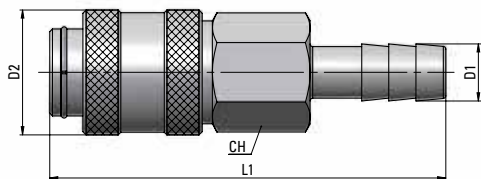

Tipo	Øi Tubo	D1	D2	L1	CH	g $\Delta\Delta$
13 06 00	6	7,5	23	73	19	89
13 09 00	9	10,5	23	73	19	91
13 13 00	13	14,5	23	73	19	94

GU 26-15

Innesto rapido con calzamento

Coupling with Nut fitting

Coupleur avec raccord à écrou

Kupplung mit Überwurfverschraubung

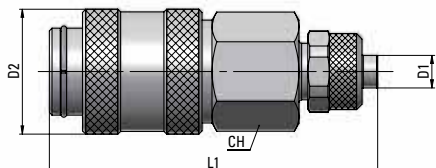

Tipo	D1	D2	L1	CH	g $\Delta\Delta$
15 08 00	8x6	23	60	19	89
15 10 00	10x8	23	61	19	103

GU 26-20

Innesto con filetto maschio

Male plug

Embout mâle

Einschraubverschlußsnippel

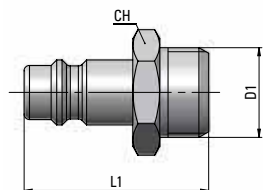

Tipo	D1	L1	CH	g $\Delta\Delta$
20 00 14	G1/4	33	17	22
20 00 38	G3/8	34	20	30
20 00 12	G1/2	37	24	50

GU 26-21

Innesto con filetto femmina

Female plug

Embout femelle

Aufschraubverschlußsnippel

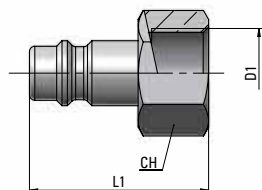

Tipo	D1	L1	CH	g $\Delta\Delta$
21 00 14	G1/4	33	17	24
21 00 38	G3/8	33	20	25
21 00 12	G1/2	36	24	40

GU 26-22

Innesto con portagomma

Plug with hose connection

Embout avec douille cannelée

Schlauchtülle

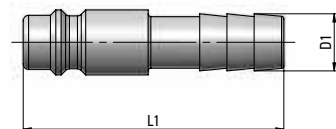

Tipo	Øi Tubo	D1	L1	g $\Delta\Delta$
22 06 00	6	7,5	48	15
22 08 00	8	9,5	48	16
22 09 00	9	10,5	48	17
22 10 00	10	11,5	48	21
22 13 00	13	14,5	48	34

GU 26-23

Innesto con raccordo a calzamento

Plug with Nut Fitting

Embout avec raccord à écrou

Verschlußtülle mit Überwurfmutter

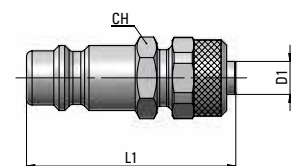

Tipo	D1	L1	CH	g $\Delta\Delta$
23 06 00	6x4	38	13	20
23 08 00	8x6	39	13	21
23 10 00	10x8	42	15	29

GU 26-24

Innesto con molla di protezione

Plug with hose protection spring

Embout avec ressort protection tube

Verschlussstülpe mit Knickschutzfeder

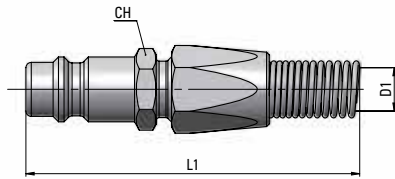

Tipo	D1	L1	CH	g $\Delta\Delta$
24 06 00	6x4	120	13	30
24 08 00	8x6	125	13	34
24 10 00	10x8	135	15	52,5

GU 10-11

Innesto rapido multipresa

Multi socket quick coupler

Coupleur multiprofil

Multiprofilkupplung

1	2	3	4	5	GU 11
Corpo Body Corps Körper	Otturatore Valve Clapet Ventil	Molle Springs Ressorts Feder	Guarnizioni Seals Joint d'étanchéité Dichtung	Sfere Balls Billes Kugel	Innesti Plugs Embouts Stecker
Ottone UNI EN 12164 CW614N Nichelato Brass UNI EN 12164 CW614N Nickel plated Laiton UNI EN 12164 CW614N Nickelé Ms Vernickelt UNI EN 12164 CW614N	Ottone UNI EN 12164 CW614N Nichelato Brass UNI EN 12164 CW614N Nickel plated Laiton UNI EN 12164 CW614N Nickelé Ms Vernickelt UNI EN 12164 CW614N	Acciaio Inox AISI 302 Stainless Steel AISI 302 Acier Inox AISI 302 Edelstahl AISI 302	NBR NBR NBR NBR	Acciaio Inox AISI 420 Stainless Steel AISI 420 Acier Inox AISI 420 Edelstahl AISI 420	Acciaio Nichelato Nickel plated steel Acier Nickelé Stahl Vernickelt

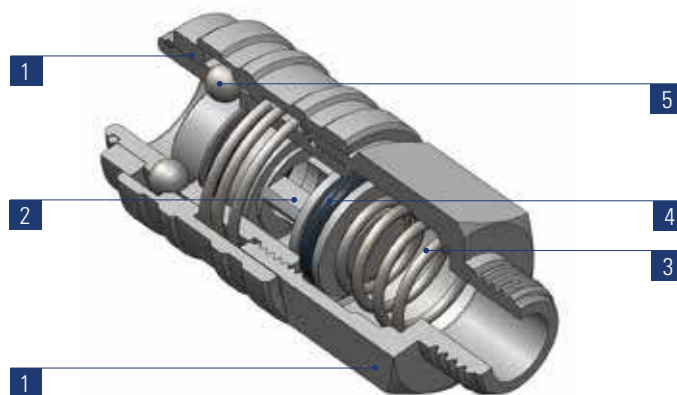
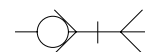
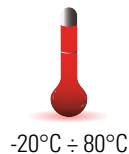

<p>Intercambiabilità con i profili Suitable with following plugs profiles Interchangeable avec les suivants profils Austauschbar mit folgenden Profilen</p>	<p>Portata Flow rate Débit Durchfluß</p> <p>(6 bar - Δp = 1 bar)</p>
---	--

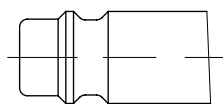

Profilo Europeo
European Profile
Profil européen
Europäisches Profil

820

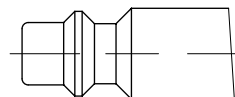

Profilo ISO 6150 B
ISO 6150 B Profile
Profil ISO 6150 B
ISO 6150 B Profil

715

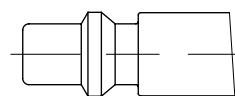

Profilo Svedese
Standard Swedisch Profile
Profil Standard Suédois
Standard schwedisches Profil

725

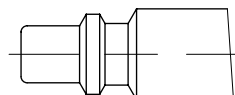

Profilo Italiano
Standard Italian Profile
Profil Standard Italien
Standard Italienisches Profil

670

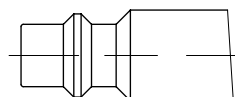

Profilo MIL C4109
MIL C4109 Profile
Profil MIL C4109
MIL C4109 Profil

715

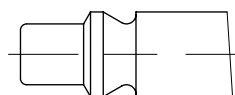

Profilo ARO 210
ARO 210 Profile
Profil ARO 210
ARO 210 Profil

705

Scala 1:1 - Scale 1:1 - Echelle 1:1 - Maßstab 1:1

GU 10-11

Innesto rapido con filetto maschio

Male coupling

Coupleur mâle

Einschraubkupplung

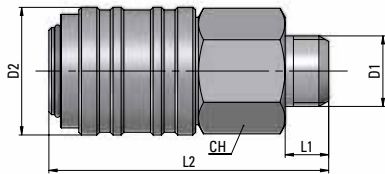

Tipo	D1	D2	L1	L2	CH	g $\Delta\Delta$
11 00 14	G1/4	23,5	10	52	20	88
11 00 38	G3/8	23,5	11	52	20	92
11 00 12	G1/2	23,5	11	52	24	118

GU 10-12

Innesto rapido con filetto femmina

Female coupling

Coupleur femelle

Aufschraubkupplung

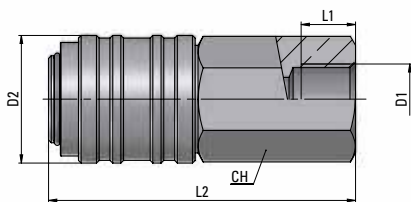

Tipo	D1	D2	L1	L2	CH	g $\Delta\Delta$
12 00 14	G1/4	23,5	10	57	20	109
12 00 38	G3/8	23,5	11	58	20	104
12 00 12	G1/2	23,5	11	60	24	134

GU 10-13

Innesto rapido con portagomma

Coupling with hose connection

Coupleur avec douille cannelée

Kupplung mit Schlauchtülle

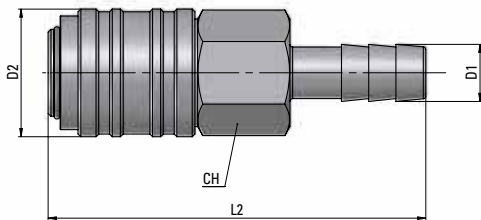

Tipo	Ø: Tubo	D1	D2	L2	CH	g $\Delta\Delta$
13 06 00	6	7,5	23,5	70	20	92
13 09 00	9	10,5	23,5	70	20	93
13 13 00	13	14,5	23,5	70	20	107

GU 11-20

Innesto Italia con filetto maschio

Male plug, Italian profile

Embout mâle, profil italien

Einschraubverschußnippel,
italienisches Profil

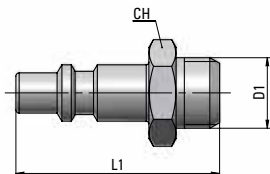

Tipo	D1	L1	CH	g $\Delta\Delta$
20 00 14	G1/4	37,5	14	17
20 00 38	G3/8	40	19	28
20 00 12	G1/2	40,5	24	43

GU 11-21

Innesto Italia con filetto femmina

Female plug, Italian profile

Embout femelle, profil italien

Aufschraubverschußnippel,
italienisches Profil

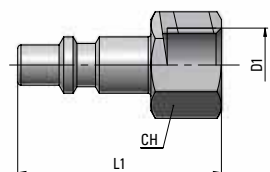

Tipo	D1	L1	CH	g $\Delta\Delta$
21 00 14	G1/4	39	17	23
21 00 38	G3/8	41	19	26
21 00 12	G1/2	44	25	51,1